



**Spraying Systems Co.**  
Experts in Spray Technology

## SPRAYDRY® NOZZLES

TO MATCH YOUR PERFORMANCE  
REQUIREMENTS – CHOOSE FROM A WIDE  
RANGE OF STYLES, SIZES AND OPTIONS







**SPRAYING SYSTEMS CO.  
THE PIONEER IN SPRAY DRYING**

- 1937:** Spraying Systems Co. is founded and develops the first line of commercial nozzles for spray drying
- 1940s:** Spraying Systems Co. establishes the term SprayDry
- 1951:** SprayDry becomes a registered trademark



# SPRAYDRY® NOZZLES TO MEET EVERY PRODUCTION NEED

Spray dryer performance is largely dependent on the spray dry nozzles. Partnering with a company with spray dry technology expertise, a proven-track record and an extensive product range ensures a nozzle that delivers the exact performance required for your products. Spraying Systems Co. is the only manufacturer that meets this criteria.

**Broadest product line available:**

- Swirlchamber, core and whirlchamber designs
- Multiple configuration options and hundreds of interchangeable components for each style ensures you will find the drop size required for your operation

**All of our SprayDry nozzles produce a uniform, hydraulically atomized hollow cone spray and are designed to:**

- Extend wear life
- Reduce maintenance time
- Reduce clogging

**Plus, we offer:**

- Quick delivery
- Computational Fluid Dynamics (CFD) modeling
- Drop size testing

**We have a proven track record of satisfied customers who have:**

- Extended nozzle wear life by up to 50%
- Increased production by 20% or more
- Improved bulk density

## TAP INTO LOCAL SPRAY EXPERTISE



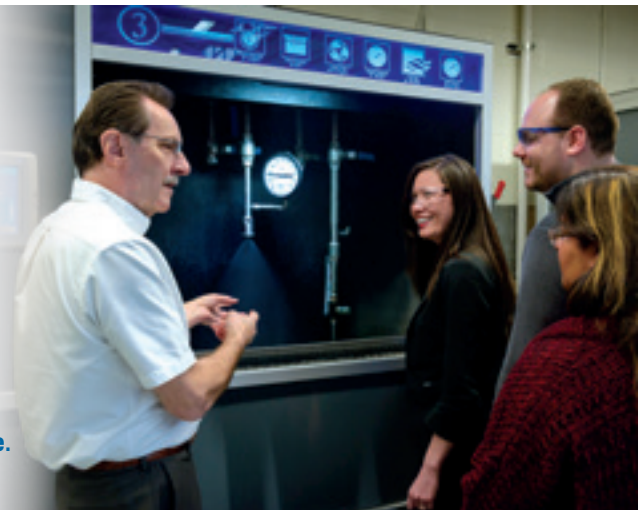

With more than 90 sales offices around the world backed by a Global Spray Drying team of technical specialists and engineers, we can support you wherever you are. Ask about SprayDry Nozzle Seminars to learn about the technical aspects of spray drying and to obtain practical advice on how to optimize your spray dryer.

Drop size affects powder properties, so effective spray drying requires precise drop size measurement and control. Our eight state-of-the-art spray laboratories located around the world can perform advanced testing to help optimize your production.

**See page 22 for more information about the research and testing services available.**



## QUICK REFERENCE GUIDE

Nozzle Type		Capacity range gph (l/hr)	Pressure range psi (bar)	Spray Angle* Range	Drop Size Range (Dv0.5 microns)	Description	Page
	<b>SV SprayDry Nozzles</b> Swirlchamber and orifice insert design	4.6 to 3,003 (17.4 to 11,366)	200 to 10,000 (13.8 to 690)	49° to 90°	20 to 650	<ul style="list-style-type: none"> <li>Largest maximum free passage</li> <li>Ideal for spraying slurries with high solids such as milk and whey</li> </ul>	8
	<b>SK SprayDry Nozzles</b> Slotted core and orifice insert design	2.8 to 400 (10.6 to 1514)	500 to 7,000 (35 to 480 bar)	44° to 90°	30 to 150	<ul style="list-style-type: none"> <li>Low flow rates</li> <li>Small droplets that evaporate quickly</li> <li>Ideal for infant formula and pharmaceuticals</li> </ul>	10
	<b>SB SprayDry Nozzles</b> Slotted core and orifice insert design	38.9 to 1,508 (147 to 5,708)	500 to 7,000 (35 to 480 bar)	34° to 109°	40 to 200	<ul style="list-style-type: none"> <li>Spray viscous liquids effectively</li> <li>Ideal for flavorings and dairy products</li> </ul>	12
	<b>AA104 &amp; AA-SSTC WhirlJet SprayDry Nozzles</b> Whirlchamber and orifice insert design	10.2 to 3,019 (39 to 11,427)	100 to 5,000 (7 to 340 bar)	19° to 104°	50 to 1000	<ul style="list-style-type: none"> <li>Coarser droplets</li> <li>Lower pressures</li> <li>Ideal for coffee and detergents</li> </ul>	14

\*Measured close to the orifice. For more information on spray angles see page 20.

### DROP SIZE COMPARISON: SV, SK/SB AND WHIRLJET SPRAYDRY NOZZLES

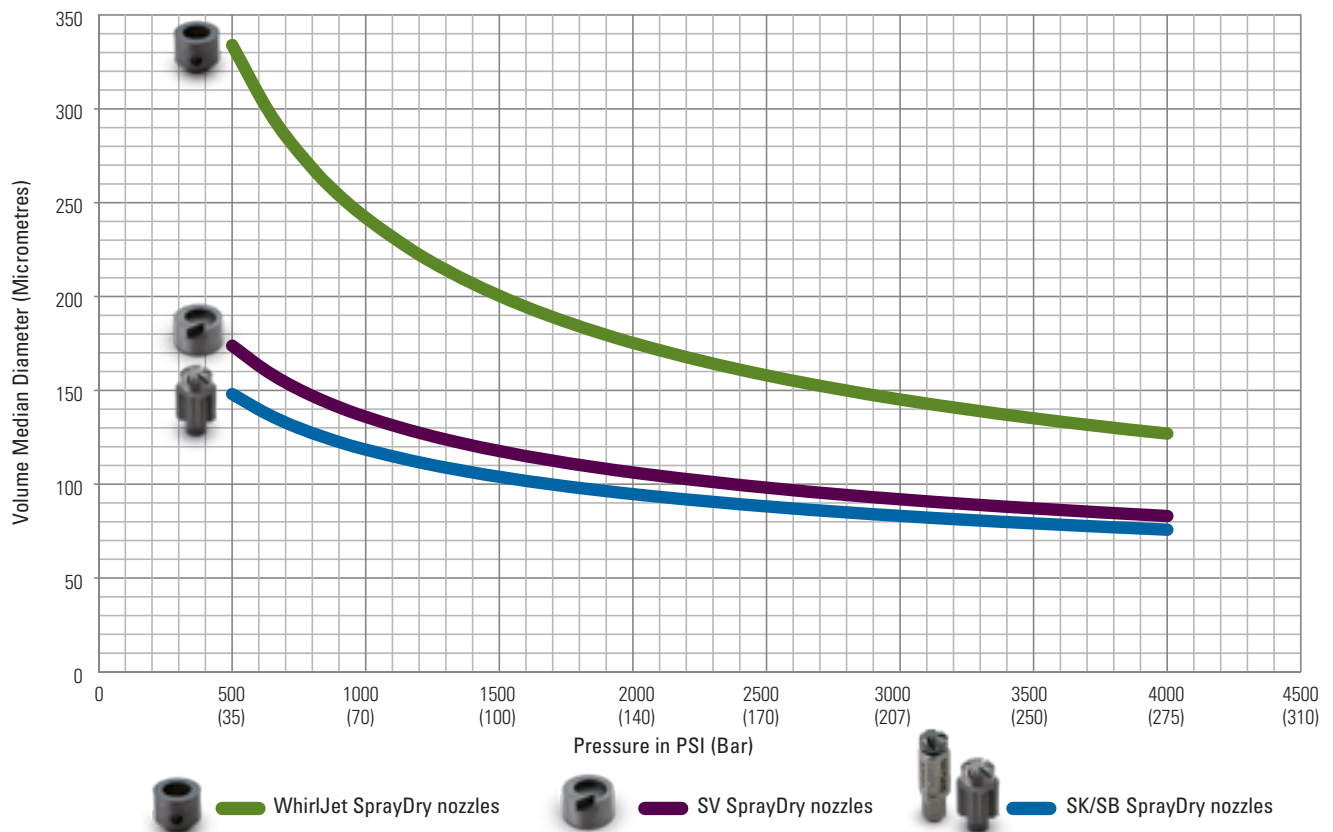

\*Spraying water at 70°F (21°C). Dv0.5 shown at various pressures for WhirlJet AA104 with WC5 and WI3; SV with SVS6 and SVI103; SB with SBBY44 and SIBY40.





## EXTEND NOZZLE WEAR LIFE

Extending the wear life of nozzle components increases production uptime and reduces the time and costs associated with nozzle change out.

Abrasive slurries sprayed at high pressure cause nozzle wear. The wear rate depends on factors such as solids in the feed stock, orifice and core sizes, spraying pressure and nozzle materials of construction. Wear problems may also be aggravated by corrosion from the feed stock or cleaning chemicals.

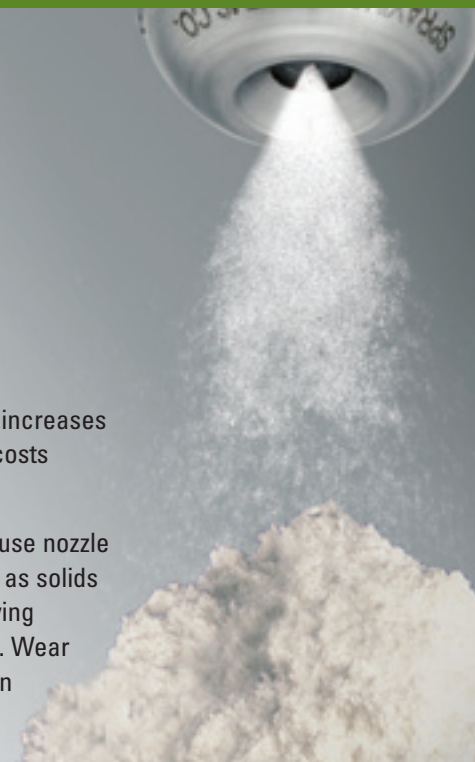

New Orifice Competitor



New SV Orifice Spraying Systems Co.



Worn Orifice Competitor:  
**20% increase in flow rate**



Worn SV Orifice Spraying Systems Co.:  
**10% increase in flow rate**

NOTE: the orifice retains its round shape



NOTE: Worn orifices are shown after 40 hours spraying an abrasive slurry at 1,000 psi (70 bar)

### Worn nozzles can be difficult to detect, but will result in:

- Increased flow
- Pressure decrease
- Irregular spray or “streaky” pattern
- Build-up on the chamber walls
- Large drops that cause wet powder, dryer fouling or wasted product

Take advantage of our no-charge evaluation service. Send us worn nozzles from your dryer. We'll examine them and provide suggestions on how to extend nozzle wear life.

### To extend wear life:

- Track how many hours you can operate before detecting product quality problems
- Reduce nozzle operating pressure if you are able to maintain the same particle size and product quality
- Choose longer lasting nozzle materials, such as:
  - Hardened stainless steel for good wear resistance
  - “Y” tungsten carbide for superior wear resistance
  - “M” tungsten carbide for ultimate wear resistance
  - “L” tungsten carbide for superior corrosion resistance



## CASE STUDY

### PROBLEM:

A cheese and dairy ingredients manufacturer was using a competitive nozzle that lasted only 24 hours before performance deteriorated.

### SOLUTION:

SV SprayDry nozzles, with swirlchamber and orifice components made of “M” tungsten carbide replaced the competitive nozzles. **Wear life increased to 48 hours, doubling the production capacity before maintenance was required.**



**INCREASE FLOW TO INCREASE PRODUCTION**

Here are three strategies commonly used to boost production.

- Increase flow by increasing orifice size**  
 Increasing the orifice size while maintaining pressure increases flow rate. Be sure to check that the dryer has enough evaporative capacity to handle the higher flow rates and enough residence time to handle the larger drops that will be produced
- Increase flow by increasing pressure**  
 One option is to use the same nozzle, but beware that higher pressure will result in smaller drops. Another option is to use a different nozzle type – or a different orifice and core/swirlchamber/whirlchamber combination – to maintain the same drop size at a higher pressure and flow
- Increase flow by using a multi-orifice nozzle**  
 The same size orifice and operating pressure will produce the same droplet/particle size. Or, use a multi-orifice nozzle that produces smaller drops when splitting the flow rate through two, three or four orifices. This results in smaller drops that evaporate more quickly and will increase the rate of powder production



Multi-orifice 3SK SprayDry® Nozzle

**EXAMPLES OF INCREASING FLOW AND PRODUCTION**

Nozzle Type	No. of Nozzles	Orifice Dia.	Pressure	Flow Rate	Drop Size Dv0.5	Example of How to Increase Production
SKHN-MFP + SIY71 + SKY21-MFP	1	.026" (0.66 mm)	2,500 psi (172 bar)	25 gph (95 l/hr)	44	Base nozzle for example
SKHN-MFP + SIY69 + SKY21-MFP	1	.029" (0.73 mm)	2,500 psi (172 bar)	30 gph (114 l/hr)	46	Increase flow rate by increasing orifice diameter
SKHN-MFP + SIY71 + SKY21-MFP	1	.026" (0.66 mm)	4,000 psi (275 bar)	30 gph (114 l/hr)	38	Increase flow rate by increasing pressure
Multi 2SK + SIY71 + SKY21-MFP	1 with 2 orifices	.026" (0.66 mm)	2,500 psi (172 bar)	25 gph * 2 = 50 gph (189 l/hr)	44	Use Multi-2SK to double the flow rate. Be sure to confirm that you have enough evaporative capacity
Multi 3SK+SIY77 + SKY20-MFP	1 with 3 orifices	.018" (0.45 mm)	2,500 psi (172 bar)	10 gph * 3 = 30 gph (114 l/hr) total flow	34	Use Multi 3SK to triple flow rate and produce smaller drops – increasing the rate of powder production



**CASE STUDY**

**PROBLEM:**

A major food ingredient manufacturer needed to increase production.

**SOLUTION:**

One of the five nozzles in the tower was changed to a multi-orifice 3SK SprayDry nozzle to take advantage of higher flow capacity and smaller drops. **This simple change enabled the manufacturer to increase production by 20%.**



## ADJUST BULK DENSITY

Bulk density is the weight of dry powder per unit volume. This determines how tightly a bag or container is packed with powder, the size of the bag or container required and has a dramatic impact on shipping and handling costs. SprayDry® nozzles provide multiple ways to adjust bulk density.

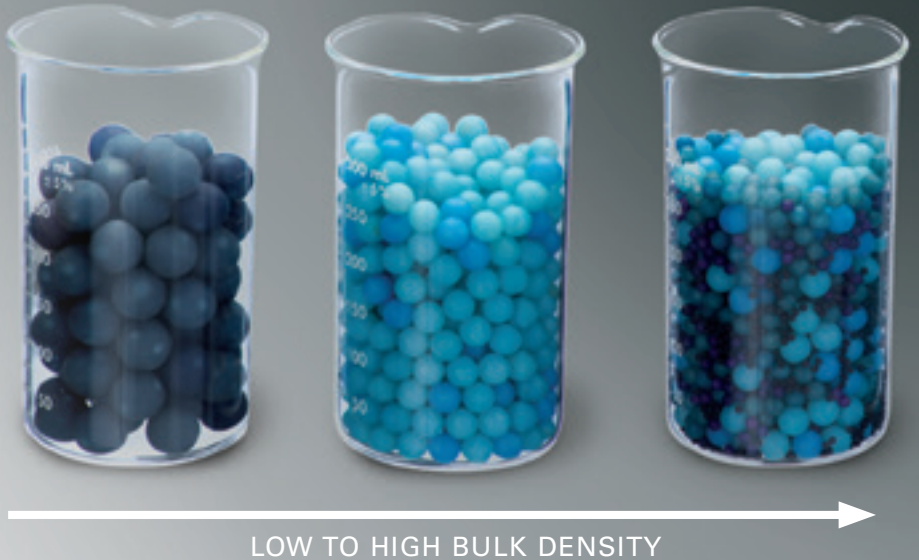

## INCREASE BULK DENSITY BY PRODUCING SMALLER DROPS

In a homogenous powder, smaller particles result in a higher bulk density than coarser particles.

**Here are some ways to generate smaller drop sizes and smaller particles:**

- Using your current nozzle, increase your nozzle operating pressure
- Use a slotted core design that provides the smallest drop size of any other design at the same flow and pressure. In addition, this design provides a very narrow distribution of drops
- Use a multi-orifice nozzle that would produce even smaller drops when splitting the flow rate by 2, 3, or 4 orifices

## DECREASE BULK DENSITY BY PRODUCING LARGER DROPS

- Using your current nozzle, decrease your nozzle operating pressure
- Use a swirlchamber or whirlchamber design that provides larger drops than slotted core designs at the same flow and pressure

## MAINTAIN A NARROWER DROP SIZE DISTRIBUTION

All spray nozzles produce a range of drop sizes, which includes some smaller particles and some larger particles. However, a very wide drop size distribution of extremely large and extremely small drops can negatively affect bulk density. The smallest drops produce tiny, dusty fines that do not completely fill the large spaces between the largest particles.

In practice, a narrower drop size distribution reduces both the fines that overload cyclones and the large drops that build-up in the dryer. Keeping most of the drops in the middle of the spectrum generally results in a more tightly packed powder with higher bulk density. Spraying Systems Co. SprayDry nozzles produce drop size distributions that are among the narrowest in the industry.

**(See drop size graph on page 7 for more information.)**

## INCREASE MOISTURE CONTENT

Bulk density can also be affected by moisture content of the dried powder. Particles containing more moisture generally have higher bulk density.

**To increase moisture content:**

- Increase flow by using larger capacity nozzles
- Keeping flow the same, decrease pressure to increase drop size
- Reduce spray angle for a slight increase in drop size and spray velocity





**SPRAY HIGH SOLIDS, VISCOUS LIQUIDS**

Spraying feed with high solid content maximizes production. A small increase in solid content can result in a large increase in production. However, increasing solid content is challenging because this increases the feed viscosity, making atomization more difficult.

**Spraying more viscous liquids at the same pressure with the same nozzle also:**

- Increases flow rate on some nozzle designs
- Decreases spray angle
- Generates larger drops and larger particle size

If these factors are not addressed, the spray dryer can easily become fouled by large droplets, resulting in short runtimes.

**Two ways to meet the challenges of spraying higher solids, more viscous liquids:**

- Increase the pressure and re-size the orifice. Higher pressures will maintain the desired drop size and the re-sized orifice will maintain the flow rate
- Consider alternate nozzle designs

**A swirlchamber design** is good for spraying higher solids. This design has one inlet and the largest maximum free passage to reduce clogging



**Slotted core designs** are good for spraying higher viscosity feeds because the core has multiple inlets which result in increased shearing force on the liquid



**MINIMIZE WALL WETTING**

Spray dryer walls that are wet result in wasted product and more frequent cleaning times.

**If you are experiencing problems:**

- Choose nozzles that provide a narrower spray angle
- Keeping flow constant, increase pressure and re-size the nozzle to reduce drop size
- Monitor and replace nozzles regularly to avoid larger drops caused by worn orifices

**PREVENT OVERLOADING OF CYCLONES**

Very small drops result in fines of powder which can overload cyclones, cause dusty emission and product loss.

**To address this problem:**

- Check heat settings to make sure particles are not over-dried, causing fractured particles
- Use larger capacity nozzles at lower pressure
- Consider nozzles that provide a narrower drop size distribution

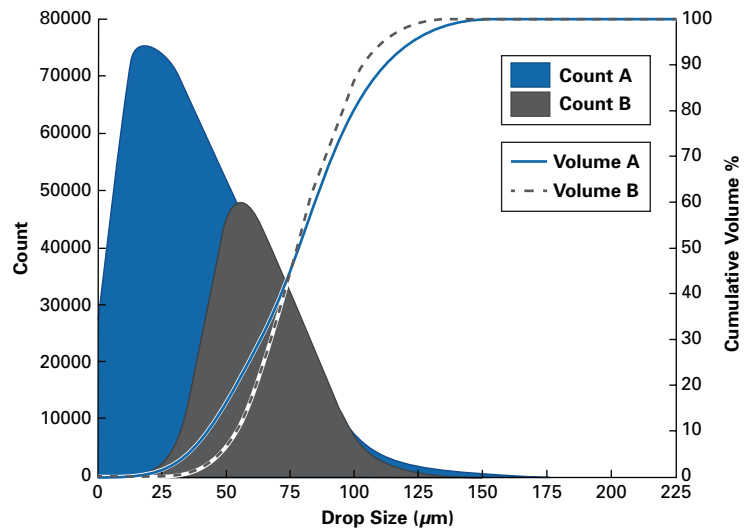

This chart shows two drop size distribution comparisons having the same Dv0.5, but different Dv0.1 and Dv0.9 values. Nozzle “B” has the narrower drop size distribution and produces fewer very large and very small drops, minimizing both wall wetting and fines.

**More information on drop size and Relative Span Factor can be found in the Technical Reference Section.**



# BETTER PERFORMANCE, BETTER DELIVERY AND BETTER VALUE



SVC  
SprayDry Nozzle

## FEATURES AND BENEFITS

- **One-piece swirlchamber design**
- **Longer wear life** – Swirlchambers and orifices are made from an engineered tungsten carbide material with superior wear-resistance
- **Reduced maintenance time** – SV nozzles are precision-engineered for performance yet designed for ease-of-use. Assembling and disassembling the nozzles can be done in minutes. All components are securely retained in the cap for quick and easy handling. Plus, a hand-tight design up to 10,000 psi (690 bar) eliminates the need for special tools. Downtime is minimized so dryers can be returned to service quickly
- **More versatile** – Our SV nozzles are rated at higher standard pressures – 10,000 psi (690 bar)
- **Reduced clogging** – Large maximum free passage helps extend production runs between maintenance
- **Easy changeover** – SV nozzles are direct replacements for competitive nozzles. They provide comparable performance. Free validation samples are available – contact your local representative for details
- **Quick delivery** – Our SV nozzles are readily available and will be delivered in days, not weeks
- **Flexible installation** – Welded connections available; customizable to fit any lance
- **Food compliant** – SV nozzles materials of construction are available to satisfy food contact regulations
- **High temperature versions available upon request**
- **Competitive pricing** – Ask for a price quote and see how much you can save

SV SprayDry  
Nozzle with  
Welded Connection



SVL  
SprayDry Nozzle

SV  
SprayDry Nozzle

Swirlchamber

Orifice

SVLX  
SprayDry Nozzle

## AVAILABLE IN THREE VERSIONS

SV	Standard features
SVC	Integrated check valve prevents liquid from draining into the tower after pump shut-off
SVL	Compact version rated up to 7,000 psi (480 bar) eliminates need for backup-up-ring
SVLX	Extra compact version rated up to 5,000 psi (345 bar) fits into smaller diameter openings



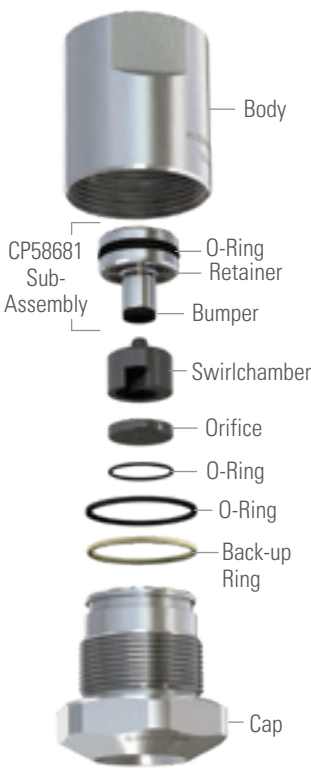
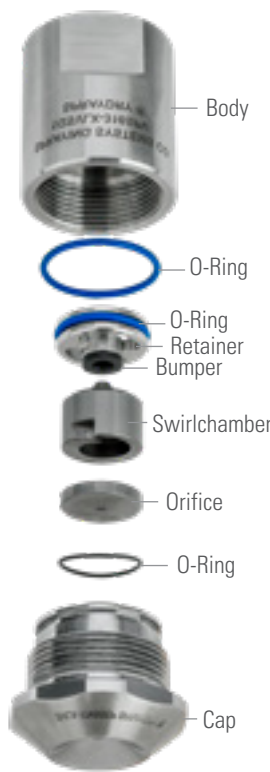

### SPECIFICATIONS

SV SprayDry Nozzle	SVLX SprayDry Nozzle
 <p>Body</p> <p>CP58681 Sub-Assembly</p> <p>O-Ring Retainer</p> <p>Bumper</p> <p>Swirlchamber</p> <p>Orifice</p> <p>O-Ring</p> <p>O-Ring</p> <p>Back-up Ring</p> <p>Cap</p>	 <p>Body</p> <p>O-Ring</p> <p>O-Ring Retainer Bumper</p> <p>Swirlchamber</p> <p>Orifice</p> <p>O-Ring</p> <p>Cap</p>
More than 700 swirlchamber/orifice combinations	
Flow rate range: 4.6 to 3,003 gph (17.4 to 11,366 l/hr)	
Pressure range: 200 to 10,000 psi (15 to 690 bar)	
Spray angle range: 49° to 90°	
Drop size range: 20 to 650 microns Dv0.5*	

\* For more information on drop size measurement, see Technical Reference Section, page 21.

### HOW THE SV NOZZLE WORKS

Liquid slurry flows into the nozzle and through the retainer, entering the single inlet swirlchamber, which causes the liquid to rotate or “swirl” at high velocity. The swirling liquid exits the nozzle orifice breaking into atomized droplets. An air core is created and a hollow cone spray pattern of small droplets is produced.



### TYPICAL APPLICATIONS

For use in co-current, counter-current and mixed flow dryers to produce powders such as:

- Whey (e.g. WPC34, WPC80, WPI)
- Milk protein concentrate
- Infant formula
- Whole milk
- Ingredients
- Skim milk/NFDM
- Chemicals
- Permeate
- Ceramics



# SMALL PARTICLE SIZES, FAST DRYING TIME



## FEATURES AND BENEFITS

- **Fast drying times** – Low flow rates and small droplets
- **Compact design** – Easily fits through 1.25" (32 mm) diameter openings (except multi designs)
- **Narrower drop size distribution** – SK nozzles provide very uniform drop size distribution. Drop size can be fine-tuned by adjusting the nozzle's flow and pressure
- **Durable construction** – Bodies and caps are stainless steel; orifices and cores are available in either M- or Y-type tungsten carbide. M-type carbide provides greater wear resistance and is suggested for abrasive and high-pressure applications. Other materials are available upon request
- **Maximum Free Passage (MFP)** – Increased free passage minimizes clogging and increases production time
- **Anti-bearding feature** – Reduces build-up on the nozzle face and eliminates contamination and hot spot concerns
- **Flexible installation** – Welded connections available; customizable to fit any lance
- **Food compliant** – SK nozzles materials of construction are available to satisfy food contact regulations

## AVAILABLE IN FOUR VERSIONS

<b>SK</b>	Standard features
<b>SK-MFP</b>	Maximum Free Passage (MFP) feature
<b>SKH-MFP and SKHN-MFP</b>	Maximum Free Passage (MFP) feature
	Anti-bearding feature
	Hand tightening of cap simplifies maintenance – no tools required
	Integrated check valve in SKH-MFP body prevents liquid from draining into the tower
<b>Multi SK and CSK</b>	Sanitary features include self-draining exterior surfaces with smooth finish and shallow hex or flats without sharp corners
	Nozzle with two, three or four multiple orifices increases production
	Multi SK version contains integrated 100 mesh strainer



### SPECIFICATIONS

SK-MFP SprayDry Nozzle	SKH-MFP SprayDry Nozzle
	<p>Retainer — Integrated Check Valve — Spring —</p> <p>Not included in SKHN version</p>
<p>More than 150 interchangeable orifice insert/core combinations to fine tune flow rate, spray angle and drop size</p>	
<p>Flow rate range: 2.8 to 400 gph (10.6 to 1,514 l/hr)</p>	
<p>Pressure range: 500 to 7,000 psi (35 to 480 bar)</p>	
<p>Spray angle range: 44° to 90°</p>	
<p>Drop size range: 30 to 150 microns Dv0.5*</p>	

\* For more information on drop size measurement, see Technical Reference Section, page 21.

### HOW THE SKH NOZZLE WITH CHECK VALVE WORKS

As the liquid slurry enters the nozzle, the check valve opens and the liquid passes through multiple core slots. These slots make the liquid rotate at high velocity, creating an air core. The liquid then exits the orifice as a hollow cone spray pattern of small droplets. When the pump shuts off, the check valve closes.



### TYPICAL APPLICATIONS

Commonly used in box dryers, pilot dryers and co-current dryers to produce powders such as:

- Infant formula
- Pharmaceuticals
- Vitamins
- Vaccines
- Starch
- Maltodextrin
- Proteins
- Milk products





# CLOG-RESISTANT, NARROW DROP SIZE DISTRIBUTION



## FEATURES AND BENEFITS

- **Narrower drop size distribution** – SB nozzles provide very uniform drop size distribution. Drop size can be fine-tuned by adjusting the nozzle’s capacity and pressure
- **Durable construction** – Bodies and caps are stainless steel and orifices and cores are available in either M- or Y-type tungsten carbide. M-type carbide provides greater wear resistance and is suggested for abrasive and high-pressure applications. Other materials are available upon request
- **Maximum Free Passage (MFP)** – Increased free passage minimizes clogging and increases production time
- **Anti-bearding feature** – Reduces build-up on the nozzle face and eliminates contamination and hot spot concerns
- **Flexible installation** – Welded connections available; customizable to fit any lance
- **Food compliant** – SB nozzles materials of construction are available to satisfy food contact regulations



## AVAILABLE IN THREE VERSIONS:

<b>SB</b>	Standard features
<b>SB-MFP</b>	Increased free passage
<b>SBH-MFP and SBHN-MFP</b>	Maximum Free Passage (MFP) feature
	Anti-bearding feature
	Hand tightening of cap simplifies maintenance – no tools required
	Integrated check valve in the SBH-MFP body prevents liquid from draining into the tower
	Sanitary features include self-draining exterior surfaces with smooth finish and shallow hex or flats without sharp corners



### SPECIFICATIONS

SB-MFP SprayDry Nozzle	SBH-MFP SprayDry Nozzle

More than 150 interchangeable orifice insert/core combinations to fine tune flow rate, spray angle and drop size

Flow rate range: 38.9 to 1,508 gph (147 to 5,708 l/hr)

Pressure range: 500 to 7,000 psi (35 to 480 bar)

Spray angle range: 34° to 109°

Drop size range: 40 to 200 microns Dv0.5\*

More than 150 interchangeable orifice insert/core combinations to fine tune flow rate, spray angle and drop size

Flow rate range: 38.9 to 1,508 gph (147 to 5,708 l/hr)

Pressure range: 500 to 7,000 psi (35 to 480 bar)

Spray angle range: 34° to 109°

Drop size range: 40 to 200 microns Dv0.5\*

\* For more information on drop size measurement, see Technical Reference Section, page 21.

### HOW THE SB SPRAYDRY NOZZLE WORKS

The liquid slurry enters the nozzle and passes through multiple slots in the core. These slots make the liquid rotate at high velocity, creating an air core. The liquid then exits the orifice as a hollow cone spray pattern of small droplets.

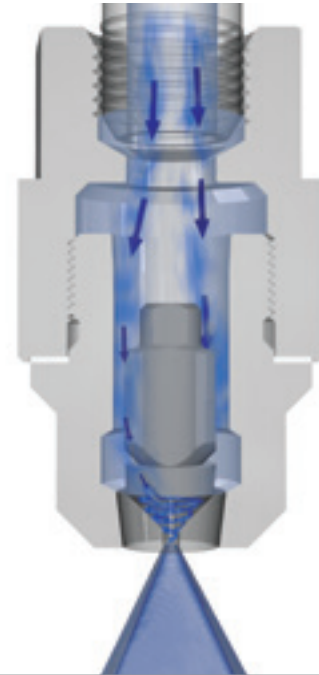

### TYPICAL APPLICATIONS

For use in co-current and counter-current dryers to produce powders such as:

- Flavorings
- Ingredients
- Extracts
- Whole milk
- Skim milk/NFDM
- Milk protein concentrate
- Casein
- Whey

# LARGE PARTICLE SIZES FOR HIGH VOLUME OPERATIONS

## FEATURES AND BENEFITS

- **Larger orifices produce large particles** – Unique whirlchamber design ensures optimal performance from WhirlJet® SprayDry nozzles. Interchangeable orifice inserts and whirlchambers ensure you can select a nozzle to meet your application requirements. You can also count on uniform drop distribution and consistent particle size with minimal product waste
- **Durable construction** – Bodies and caps are stainless steel. Orifices and whirlchambers are available in either M- or Y-type tungsten carbide. M-type carbide provides greater wear resistance and is suggested for abrasive and high-pressure applications. Other materials are available upon request
- **Flexible installation** – Welded connections available; customizable to fit any lance
- **Food compliant** – WhirlJet nozzles materials of construction are available to satisfy food contact regulations



## AVAILABLE IN TWO VERSIONS:

<b>AA104</b>	For high pressure applications – up to 5000 psi (340 bar)
	Stainless steel lock screw to securely hold the whirlchamber against the orifice insert
	Capacity sizes up to 3019 gph (11,340 l/hr)*
<b>AA-SSTC</b>	Used at pressures up to 1000 psi (70 bar) and are designed for quick assembly
	Stainless steel spring is used to hold the whirlchamber against the orifice insert
	Capacity sizes from 10.2 to 1350 gph at 1000 psi (39 to 5140 l/hr at 70 bar)

\*Values are based on water spraying at 70°F (21°C) in lab conditions.



## CHOICE OF WHIRLCHAMBER STYLES:

 <b>Flat-bottom</b>	Large passage to minimize clogging and downtime
 <b>Slope-bottom</b>	Minimizes erosion in the whirlchamber bottom by reducing the drilling effect of the air core for extended wear life





**SPECIFICATIONS**

**WhirlJet AA104**



**WhirlJet AA-SSTC**

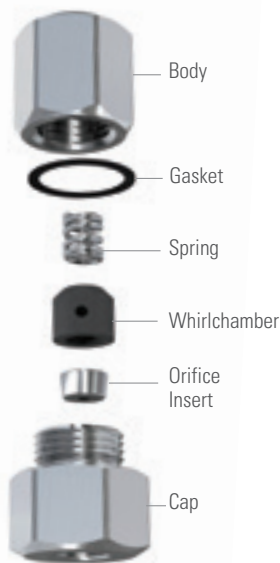

More than 150 interchangeable orifice insert/core combinations to fine tune flow rate, spray angle and drop size

Flow rate range: 10.2 to 3,019 gph (39 to 11,427 l/hr)

Pressure range: 100 to 5,000 psi (7 to 340 bar)

Spray angle range: 19° to 104°

Drop size range: 50 to 1,000 microns Dv0.5\*

\* For more information on drop size measurement, see Technical Reference Section, page 21.

**HOW THE AA104 NOZZLE WORKS**

Liquid slurry enters the nozzle and passes through holes in the lock screw. The liquid then enters the whirlchamber and begins to rotate or “whirl” at high velocity. The rotation forces the liquid toward the edges of the whirlchamber creating an air core and a hollow cone pattern as the liquid exits the orifice.



**TYPICAL APPLICATIONS**

For use in co-current and counter-current dryers to produce powders such as:

- Coffee
- Detergents
- Ceramics
- Dyestuffs
- Pigments
- Silica
- Catalysts
- Fertilizers



## ANTI-BEARDING CAPS TO PREVENT PRODUCT BUILD-UP

Product build-up on the nozzle or “bearding” can be caused by the nozzle design and the dryer environment.

During spray drying, a low-pressure zone is created by the high-velocity spray exiting from the nozzle orifices. This zone draws fine droplets back to the cap which may dry and cause build-up. If bearding is left unattended, the build-up can block the orifices, contaminate the batch, cause dangerous hot spots and result in burned product.

Bearding on the nozzle can also occur due to the nozzle location within the dryer and the air flow direction and velocity. The air in the dryer can force droplets to accumulate on the face or on the sides of the nozzle. Placement of the nozzle above the eddy air currents helps prevent build-up.

Nozzle design, including cap geometry, shapes and angles can be altered to prevent bearding. The type of cap used will depend on the nozzle design, operating parameters and particular dryer conditions.

## VARIOUS ANTI-BEARDING CAP GEOMETRIES ARE AVAILABLE:

- Flat face and bullet-shaped designs
- Various cone shapes
- Special caps available on request

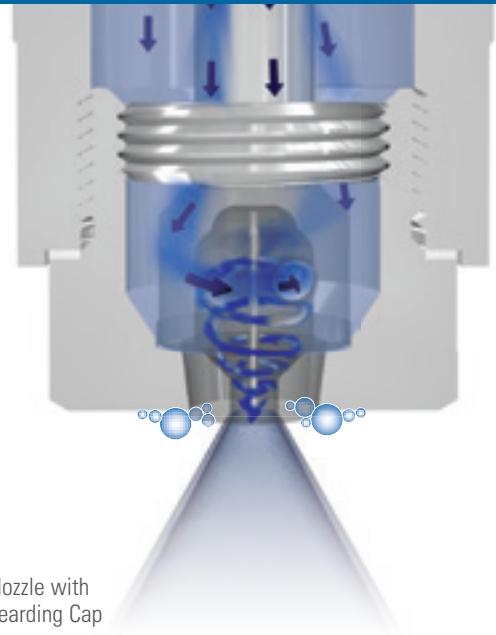

## CASE STUDY:



### PROBLEM:

A food ingredient manufacturer was using multiple nozzles in their spray dry tower. Frequent, difficult manual cleaning was required due to build-up on the cone-shaped cap of the nozzles.

### SOLUTION:

A simple change to a flat style cap significantly reduced the amount of build-up on the nozzle. This decreased cleaning time dramatically and increased production uptime.



## OMNI NOZZLES PROVIDE FLEXIBILITY TO ENSURE PRECISE POWDER QUALITY

OMNI SprayDry® nozzles are comprised of interchangeable caps mounted in standard nozzle bodies or lances. OMNI caps provide the ability to conveniently use the swirlchamber, slotted core and whirlchamber designs – all of which provide unique advantages – as your performance requirements change.

### IDEAL FOR:

- Product trials in pilot dryers
- Production batches
- Spraying different products in same dryer



For more information, request datasheet DS SVL OMNI

## SPRAYDRY LANCES OPTIMIZE SPRAY NOZZLE PERFORMANCE

SprayDry nozzles are designed to yield very precise performance. Equally important in a spray system is the spray lance that delivers the liquid and/or gas to the nozzle. Lances used in spray drying operations must meet exacting standards to ensure optimal performance.

- Our standard spray drying lances are available in multiple configurations with sanitary or bolt-on flanges
- Custom lances can be designed to meet challenging physical spaces or difficult spray drying environments. Optional adapters, cooling jackets, purge tubes and protective tubes are available





## ADDITIONAL PRODUCTS FOR SPRAY DRY OPERATIONS

### TANKJET® TANK CLEANING PRODUCTS: IDEAL FOR CLEANING DRYERS, VESSELS, STORAGE TANKS AND MORE

From gentle rinsing to removal of the toughest of residues, we have solutions for dryers, vessels and tanks up to 98 ft. (30 m) in diameter. Choose from powerful, high impact motor- and turbine-driven machines, spray balls, tank cleaning nozzles and more.

In addition to a wide range of products, we have decades of experience helping customers optimize cleaning operations in dairies, food, chemical and pharmaceutical plants and more. Plus, we offer local service and global coverage. With more than 90 offices around the world, we have a dryer/vessel/tank cleaning specialist in your area.



### CASE STUDY: DRYER CLEANING IN DAIRY PLANT



#### PROBLEM:

Baked-on spray dry powder. Towers ranged in size from 10 to 35 ft. (3 to 11 m) in dia. by 10 to 60 ft. (3 to 18 m) high.

**SOLUTION:** A TankJet 360 tank cleaner mounted on a hose reel and pulley wheel is lowered into the center of the dryer. At the end of the cleaning cycle, the TankJet 360 may be lowered again (depending on tower height) for additional cleaning or removed. The unit operates at pressures from 100 to 125 psi (7 to 8 bar) and flow rates ranging from 70 to 100 gpm (265 to 378 lpm), and provides high-impact, thorough cleaning of the towers. **Using the TankJet 360, the towers only require cleaning every three to five days.**

The 3A symbol is a registered trademark of 3-A Sanitary Standards, Inc.



# THE SPRAYDRY NOZZLE IS THE MOST CRITICAL COMPONENT OF THE SPRAY DRYER

Dried powder properties such as particle size, bulk density, moisture content, solubility and dispersability are all affected by the nozzle. Any changes to nozzle type, pressures, spray angles and drop size can dramatically affect production capacity and product quality.

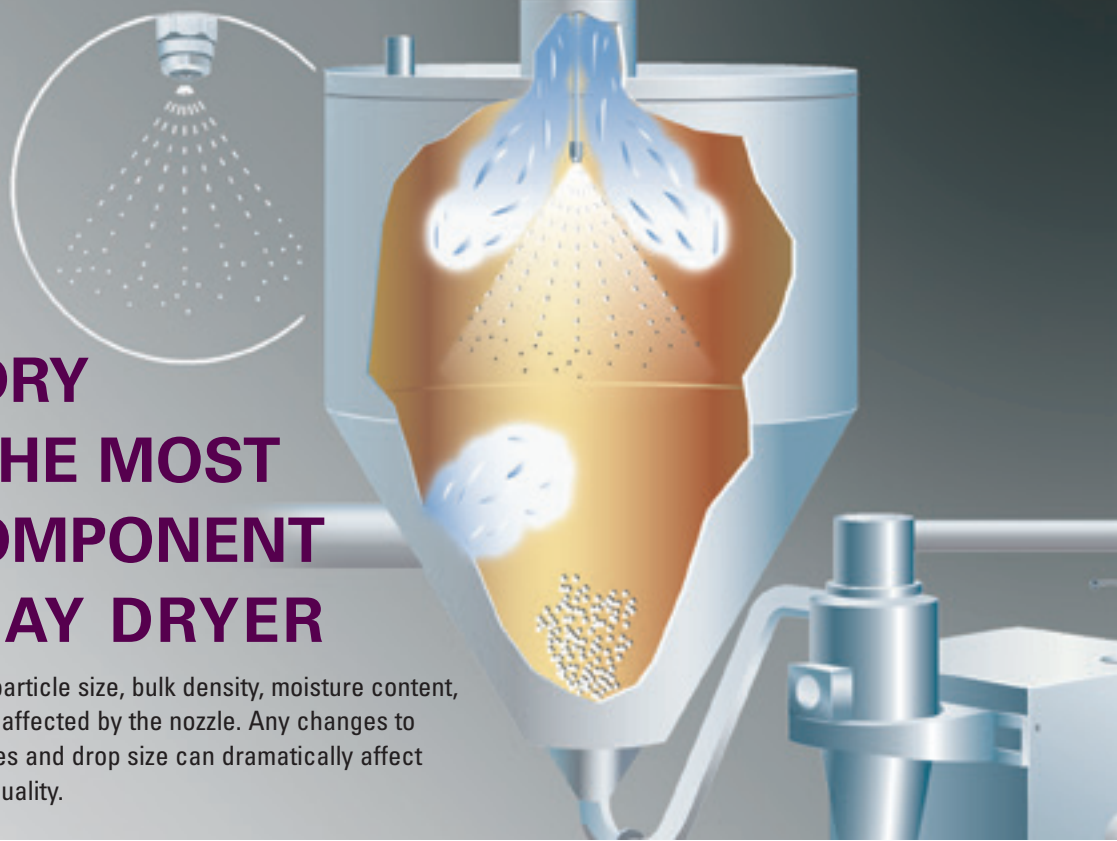

## NOZZLE TYPES

### HYDRAULIC NOZZLES

Nozzles used in spray drying are typically high pressure, hydraulic nozzles that operate up to 10,000 psi (700 bar). Three types of designs are available: swirlchamber, slotted core and whirlchamber, all of which produce hollow cone spray patterns.



### AIR ATOMIZING NOZZLES

Air atomizing nozzles are commonly used in pilot dryers and small production dryers because of the small drops they produce at relatively low liquid and air pressures.

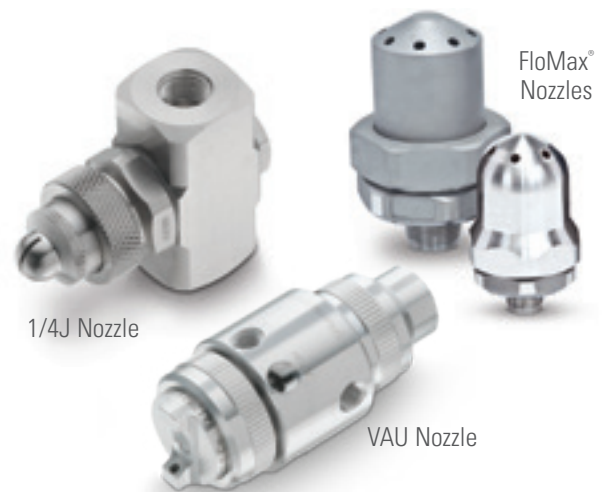

For more information on air atomizing nozzles refer to Spraying Systems Co. Catalog 76 AA-AUTO



**FLOW RATE AND LIQUID PRESSURE**

Nozzles meter liquid, controlling the flow rate to the dryer. **A change in pressure varies the flow rate and can be calculated as:**

$$\frac{GPH_1}{GPH_2} = \frac{\sqrt{PSI_1}}{\sqrt{PSI_2}}$$

$$\frac{LPH_1}{LPH_2} = \frac{\sqrt{BAR_1}}{\sqrt{BAR_2}}$$

**SPECIFIC GRAVITY**

The specific gravity of a liquid or slurry affects flow rate. **Equivalent water flow rate adjusted for specific gravity can be calculated as:**

$$GPH_{(WATER)} = GPH_{(SLURRY)} * \sqrt{SG_{(SLURRY)}}$$

$$LPH_{(WATER)} = LPH_{(SLURRY)} * \sqrt{SG_{(SLURRY)}}$$

**SPRAY ANGLE AND COVERAGE**

Spray angle affects coverage, which varies with the spray distance. Theoretical coverage can be easily calculated but in practice, spray patterns generally contract as distance from the nozzle increases. Liquids more viscous than water form relatively smaller spray angles. Liquids with surface tensions lower than water will produce relatively wider spray angles.

Choose a spray angle that will distribute liquid evenly in the gas stream when installed. The spray should not impact dryer walls or cause build-up, resulting in wasted product. When using multiple nozzles, avoid overlapping sprays that will cause larger drops to form unless this is done to agglomerate the powder.

**Ask your local Spraying Systems Co. sales engineer for more information on spray angles.**

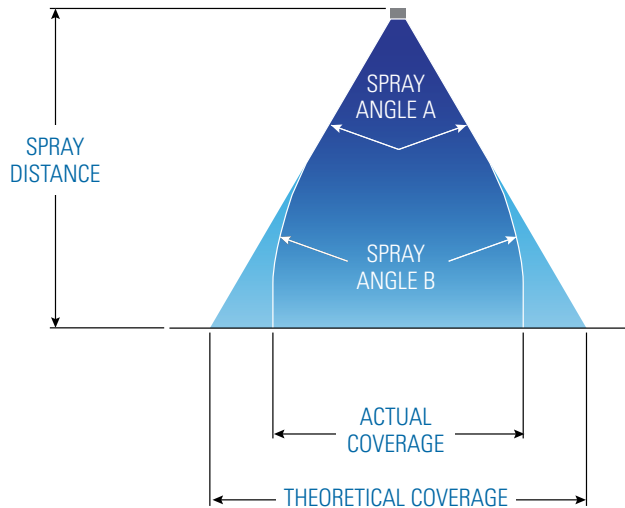

Spray Angle "A" is measured close to the orifice. Theoretical coverage at a specific spray distance can be calculated from this angle. Spray Angle "B" is measured from actual coverage at a particular spray distance. For SprayDry® nozzles, the "B" angles are measured 12 inches (30.5 cm) from the nozzle orifice.

Visit [spray.com/sprayware](http://spray.com/sprayware) for an online spray coverage calculator. Additional spray angle data can be found at [spray.com/spraydry](http://spray.com/spraydry)





**DROP SIZE**

Droplet size controls the dried powder particle sizes as well as the drying process efficiency. While the wet drop size is not necessarily equivalent to the dry particle size coming out of the dryer, the drop size is commonly used to suggest a nozzle and predict the particle size.

**ACTUAL DROP SIZES**

- 500 μm
- 1200 μm
- 5500 μm

One inch = 25,400 μm

One millimeter = 1,000 μm

μm = micrometers

Spray nozzles atomize liquid into a range of droplet sizes. This range is referred to as the drop size distribution. In practice, this droplet size spectrum is a function of the nozzle type and capacity, spraying pressure, feed stock properties and to a much lesser extent the spray angle.

- **Smaller spray droplets** (and particles) are obtained by using smaller capacity nozzles and/or by spraying at higher pressures
- **Larger spray droplets** (and particles) are produced by larger capacity spray nozzles and/or spraying at lower pressures
- **Somewhat smaller droplet sizes** (and particles) may be produced by wider spray angles, as compared to narrower spray angle sprays, for the same nozzle capacity and pressure

**Ask your local Spraying Systems Co. sales engineer for more information on drop size data for SprayDry® nozzles at various pressures and flow rates.**

**DROP SIZE TERMINOLOGY**

Terminology is often a major source of discrepancy and confusion in understanding drop size. To accurately compare the drop size from different nozzles, the same diameter terminology has to be used. Following are the most popular characteristic diameters and their definitions.

**D<sub>v0.5</sub> or Volume Median Diameter – VMD**

The value where 50% of the total volume (or mass) of liquid sprayed is made up of drops with diameters smaller or equal to this value.

NOTE: Drop size references in this catalog are VMD.

**D<sub>32</sub> or Sauter Mean Diameter – SMD**

Is the ratio of the total volume of all the drops to the total surface area of all the drops.

**D<sub>min</sub> , D<sub>max</sub>**

The minimum and maximum drop size by volume (or mass) present in the spray.

**D<sub>v0.1</sub> , D<sub>v0.9</sub>**

The values where 10% or 90% of the total volume (or mass) of liquid sprayed is made up of drops with diameters smaller or equal to this value.

**Relative Span Factor (RSF)**

A parameter indicative of the uniformity (width) of the drop size distribution, defined as:

$$RSF = \frac{D_{v0.9} - D_{v0.1}}{D_{v0.5}}$$

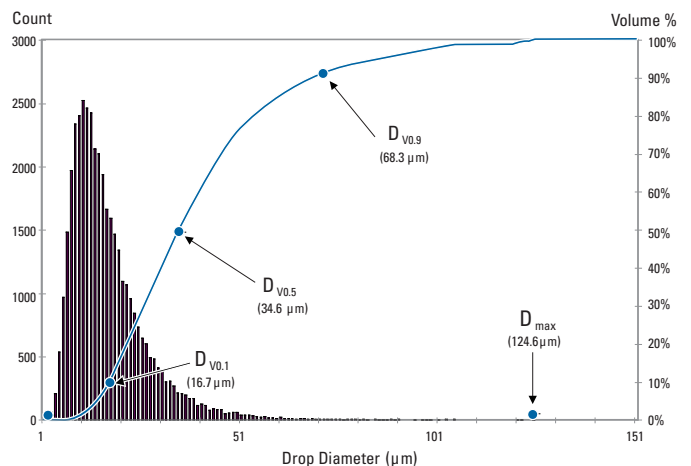

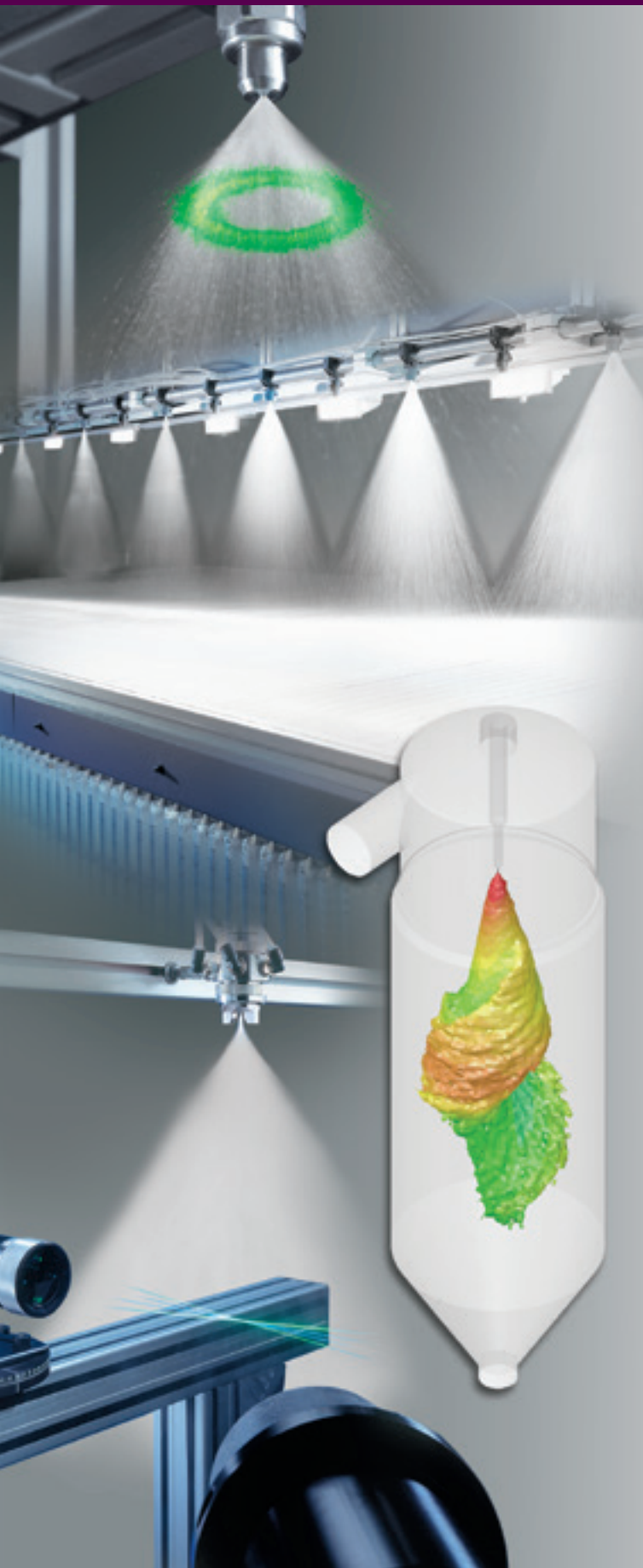

## SPRAY TESTING AND MODELING SERVICES

Spray drying requires nozzles that produce just the right drop size in order to produce the desired particle size and powder properties. The ability to measure drop size accurately and model the flow of drops in a spray dryer are important services offered by Spraying Systems Co.

Spray Analysis and Research Services of Spraying Systems Co. has state-of-the-art laboratories all over the world to help you optimize your production.

### COMMON TESTS INCLUDE:

- Spray characterization
- Drop size distribution
- Spray impact
- Spray pattern
- Spray angle
- Spray coverage
- Wear testing

### COMPUTATIONAL FLUID DYNAMICS (CFD) MODELS ILLUSTRATE:

- Flow patterns
- Velocity
- Temperature
- Gas/liquid distributions
- Droplet trajectories
- Evaporation rate
- Residence time



## ADDITIONAL RESOURCES:

[spray.com/spraydry](http://spray.com/spraydry)

### Performance Data and Ordering Information for SprayDry® Nozzles

---



### SprayDry Nozzle Selector

Find nozzle options at specific flow rates and pressures. Drop size information available upon request.

---

### SprayDry Nozzle Videos and Animations

---

#### Technical Manual

Spray Drying Nozzles and Applications

---



#### White Paper

*"Local and General Spray Characteristics of Spray Dry Nozzles with Water"*

by K.M. Bade, R.J. Schick, T. Oberg, and C. Pagcatipunan.

---

### Spray Technology Reference Guide: Understanding Drop Size

---



### TankJet® Tank Cleaning Products

---





**Spraying Systems Co.**  
Experts in Spray Technology



North Avenue and Schmale Road, P.O. Box 7900, Wheaton, IL 60187-7901 USA

Tel: 1.800.95.SPRAY Intl. Tel: 1.630.665.5000

Fax: 1.888.95.SPRAY Intl. Fax: 1.630.260.0842

[www.spray.com](http://www.spray.com)

 **PAWIN Engineering Co., Ltd.**  
168 อาคาร Axiom 1 ม. 7 ถ. กิ่งแก้ว ต. บางพลีใหญ่  
อ. บางพลี จ.สมุทรปราการ 10540

 0-2911-4761-5, 095-365-8530-1  [pawin@pawin.co.th](mailto:pawin@pawin.co.th)  [www.pawin.co.th](http://www.pawin.co.th)

